













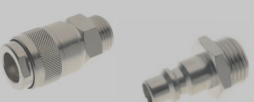



Prese ad Innesto Rapido - Quick Couplings - Schnellverschluss Kupplungen - Coupleurs Automatiques - Enchufes Rápidos - Conexões de Engate Rápido

| | | | |
|-------------------------------------------------------------------------------------------------------------------------------------------------------------------|------------------------------------------------------------------------------------------------------------------------------------------------------------------------|----------------------------------------------------------------------------------------------------------------------------------------------------------------------|-----------------------------------------------------------------------------------------------------------------------------------------------------------------------|
| <p>SERIE UNI ISO 6150 A-6</p>  <p>Serie 100 Pag. 16.7 - 16.10</p> | <p>SERIE MIGNON New</p>  <p>Serie 110 Pag. 16.11 - 16.16</p> | <p>SERIE UNI ISO 6150 B-12</p>  <p>Serie 120 Pag. 16.17 - 16.22</p> | <p>ITALIAN PROFILE</p>  <p>Serie 120 Pag. 16.23 - 16.28</p> |
| <p>SERIE UNI ISO 6150 B-15</p>  <p>Serie 130 Pag. 16.29 - 16.33</p> | <p>SERIE UNI ISO 6150 C-10</p>  <p>Serie 140 Pag. 16.34 - 16.39</p> | <p>EUROPEAN PROFILE</p>  <p>Serie 160 Pag. 16.40 - 16.45</p> | <p>SWISS PROFILE</p>  <p>Serie 170 Pag. 16.46 - 16.50</p> |
| <p>MIGNON PROFILE New</p>  <p>Serie 180 Pag. 16.51 - 16.54</p> | <p>MULTISOCKET New</p>  <p>Serie 190 - 63190 Pag. 16.55 - 16.61</p> | <p>JAPANESE PROFILE</p>  <p>Serie 400 Pag. 16.62 - 16.64</p> | <p>MINI DN 2,7</p>  <p>Serie 700 Pag. 16.65 - 16.67</p> |
| <p>SERIE UNI ISO 6150 B-17</p>  <p>Serie 710 Pag. 16.68 - 16.70</p> | <p>B-SOCKET EUROPEAN</p>  <p>Serie 720 Pag. 16.71 - 16.74</p> | <p>EUROPEAN PROFILE New</p>  <p>Serie 730 Pag. 16.75 - 16.80</p> | <p>EUROPEAN PROFILE New</p>  <p>Serie 740 Pag. 16.81 - 16.83</p> |



Prese di Sicurezza ad Innesto Rapido - Safety Quick Couplings - Kupplungen Sicherheit - Coupleurs de Sécurité - Enchufes de Seguridad - Conexões de Segurança

| | | | |
|---------------------------------------------------------------------------------------------------------------------------------------------------------------------|-----------------------------------------------------------------------------------------------------------------------------------------------------------------------|-------------------------------------------------------------------------------------------------------------------------------------------------------------|-----------------------------------------------------------------------------------------------------------------------------------------------------------|
| <p>SERIE UNI ISO 6150 B-12</p>  <p>Serie 620 Pag. 16.85 - 16.88</p> | <p>ITALIAN PROFILE</p>  <p>Serie 650 Pag. 16.89 - 16.90</p> | <p>EUROPEAN PROFILE</p>  <p>Serie 660 Pag. 16.91 - 16.92</p> | <p>SWISS PROFILE</p>  <p>Serie 670 Pag. 16.93 - 16.94</p> |
| <p>SERIE UNI ISO 6150 B-12</p>  <p>Serie 0B120 Pag. 16.97 - 16.99</p> | <p>SERIE UNI ISO 6150 C-10</p>  <p>Serie 0B140 Pag. 16.100 - 16.102</p> | | |

Giunti ad Innesto Rapido per Raffreddamento Stampi - Quick Couplings for Molding Cooling - Schnellkupplungen Für Spritzgussanwendungen
Coupleurs pour Moules D'injection - Enchufes Rápidos para Refrigeración de Moldes - Conexões de Engate Rápido para Resfriamento de Moldes

| | | | |
|--------------------------------------------------------------------------------------------------------------------------------------------------------------------------------------------|--------------------------------------------------------------------------------------------------------------------------------------------------------------------------------------------------|----------------------------------------------------------------------------------------------------------------------------------------------------------------------------------------------|--------------------------------------------------------------------------------------------------------------------------------------------|
| <p>FRENCH PROFILE DN 8 - DN 12</p>  <p>Series 410 - 420 - 510 - 520 Pag. 16.104 - 16.110</p> | <p>INTERNATIONAL PROFILE DN 6 - DN 9</p>  <p>Series 430 - 440 - 530 - 540 Pag. 16.112 - 16.119</p> | <p>EUROPEAN PROFILE DN 6 - DN 9</p>  <p>Series 460 - 470 - 560 - 570 Pag. 16.120 - 16.127</p> | <p>New</p>  <p>6049 Pag. 16.128</p> |
|--------------------------------------------------------------------------------------------------------------------------------------------------------------------------------------------|--------------------------------------------------------------------------------------------------------------------------------------------------------------------------------------------------|----------------------------------------------------------------------------------------------------------------------------------------------------------------------------------------------|--------------------------------------------------------------------------------------------------------------------------------------------|

Pistole di Soffiaggio - Blow Guns - Blaspistolen - Soufflettes - Pistolas Sopladoras - Pistola de Ar

| | | | |
|---------------------------------------------------------------------------------------------------------------------------------------------------------|---------------------------------------------------------------------------------------------------------------------------------------|--------------------------------------------------------------------------------------------------------------------------------|-----------------------------------------------------------------------------------------------------------------------------------------|
| <p>New</p>  <p>Series 360 Pag. 16.130 - 16.132</p> |  <p>Series 300 Pag. 16.133 - 16.135</p> |  <p>Spare Parts Pag. 16.136</p> |  <p>Series 340 Pag. 16.137 - 16.138</p> |
|---------------------------------------------------------------------------------------------------------------------------------------------------------|---------------------------------------------------------------------------------------------------------------------------------------|--------------------------------------------------------------------------------------------------------------------------------|-----------------------------------------------------------------------------------------------------------------------------------------|

SERIE 140 UNI ISO 6150 C-10



CARATTERISTICHE TECNICHE
 TECHNICAL CHARACTERISTICS
 TECHNISCHE ANGABEN
 CARACTÉRISTIQUES TECHNIQUES
 CARACTERÍSTICAS TÉCNICAS
 CARACTERÍSTICAS TÉCNICAS



Norma di Riferimento
 Reference standard
 Entspricht der Norm
 Norme de référence
 Normativa de referencia
 Norma de referència

| | |
|-----------------------------|-----------------------------|
| 1907/2006 REACH ✓ | 2011/65/CE RoHS ✓ |
| PED 2014/68/UE | SILICON FREE |

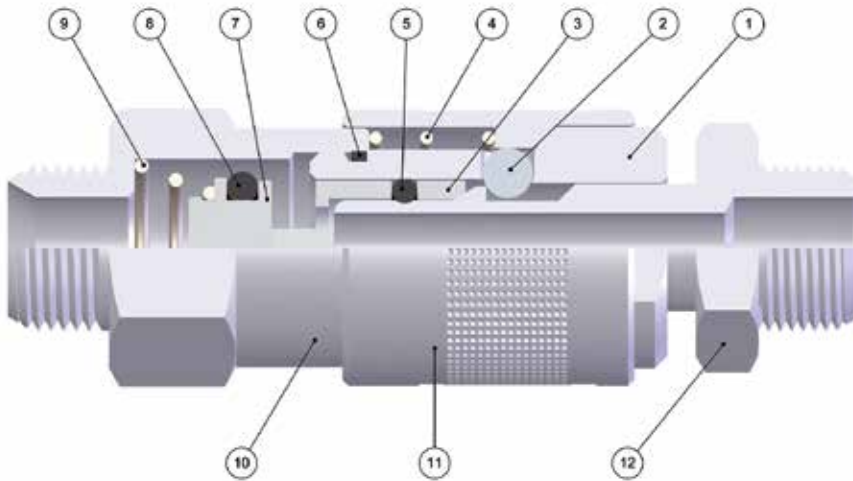

FKM A RICHIESTA
 IF REQUESTED FKM
 FKM AUF ANFRAGE
 FKM SUR DEMANDE
 FKM BAJO DEMANDA
 FKM SOB ENCOMENDA

DN
 5.5 mm

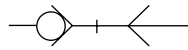

UNI ISO 6150 C-10

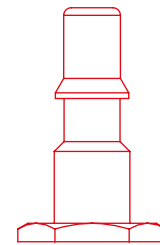

1:1

| Materiali e Componenti | IT | Component Parts and Materials | GB | Komponenten und Materialien | DE |
|------------------------------------------------------------------------------------------------------------------------------------------------------------------------------------------------------------------------------------------------------------------------------------------------------------------------------------------------------------------------------------------------------------------------------------------|----|---------------------------------------------------------------------------------------------------------------------------------------------------------------------------------------------------------------------------------------------------------------------------------------------------------------------------------------------------------------------------------------------------------------------------------|----|------------------------------------------------------------------------------------------------------------------------------------------------------------------------------------------------------------------------------------------------------------------------------------------------------------------------------------------------------------------------------------------------------|----|
| 1 Corpo in Ottone Nichelato 2 Sfera in Acciaio AISI 420 3 Anello Guida Innesto in Ottone Nichelato 4 Molla Ghiera in Acciaio AISI 302 5 Guarnizione O-Ring in NBR 6 Guarnizione O-Ring in NBR 7 Otturatore in Ottone Nichelato 8 Guarnizione O-Ring in NBR 9 Molla Otturatore in Acciaio AISI 302 10 Attacco Terminale in Ottone Nichelato 11 Ghiera in Ottone Nichelato 12 Innesto in Ottone Nichelato | | 1 Nickel-Plated Brass Body 2 Stainless Steel AISI 420 Balls 3 Nickel-Plated Brass Guide Ring Coupling 4 Stainless Steel AISI 302 Ring Nut Spring 5 NBR O-Ring Seals 6 NBR O-Ring in NBR 7 Nickel-Plated Brass Shutter 8 NBR O-Ring Seals 9 Stainless Steel AISI 302 Shutter Spring 10 Nickel-Plated Brass Coupling Back Part 11 Nickel-Plated Brass Sleeve 12 Nickel-Plated Brass Plug Outline | | 1 Körper Messing Vernickelt 2 Kugel Edelstahl AISI 420 3 Stecker Führungsring Messing Vernickelt 4 Entriegelungsfeder Edelstahl AISI 302 5 O-Ring NBR 6 O-Ring NBR 7 Verschluss Messing Vernickelt 8 O-Ring NBR 9 Verschlussfeder Edelstahl AISI 302 10 Einschraubkörper Messing Vernickelt 11 Entriegelungshülse Messing Vernickelt 12 Stecker Messing Vernickelt | |
| Matériaux et Composants | FR | Materiales y Componentes | ES | Materiais e Componentes | PT |
| 1 Corps: Laiton Nickelé 2 Bille: Acier Inoxydable AISI 420 3 Bague de Guidage: Laiton Nickelé 4 Ressort de Bague: Acier Inoxydable AISI 302 5 Joint Torique en NBR 6 Joint Torique en NBR 7 Clapet: Laiton Nickelé 8 Joint Torique en NBR 9 Ressort de Clapet: Acier Inoxydable AISI 302 10 Corps: Laiton Nickelé 11 Bague: Laiton Nickelé 12 Embout: Laiton Nickelé | | 1 Cuerpo en latón niquelado 2 Esfera en acero AISI 420 3 Anillo guía enchufe en latón niquelado 4 Muelle tuerca en acero AISI 302 5 Junta tórica en NBR 6 Junta tórica en NBR 7 Obturador en latón niquelado 8 Junta tórica en NBR 9 Muelle obturador en acero AISI 302 10 Terminal de conexión en latón niquelado 11 Tuerca en latón niquelado 12 Enchufe en latón niquelado | | 1 Corpo em Latão Niquelado 2 Esfera em aço AISI 420 3 Anel guia do plug em latão niquelado 4 Mola da porca em aço AISI 302 5 Vedação O-Ring em NBR 6 Vedação O-Ring em NBR 7 Obturador em latão niquelado 8 Vedação O-Ring em NBR 9 Mola do obturador em aço AISI 302 10 Conexão terminal em latão niquelado 11 Porca em latão niquelado 12 Plug em latão niquelado | |



Pressione d'esercizio

Working Pressures

Betriebsdruck

Pression de service

Presión de Ejercicio

Pressão de Trabalho

0 bar

25 bar



Max pressione statica (no pulsazioni)

Maximum static pressure (no pulsations)

Maximaler statischer Betriebsdruck (ohne pulsations)

Pression statique maximale (sans pulsation)

Presión estática máxima (sin pulsaciones)

Pressão estática máxima (sem pulsações)

35 bar



Temperature

Temperatures

Temperatur

Températures

Temperaturas

Temperaturas

- 20 °C

+ 80 °C

Con O-ring in FKM

With FKM O-ring

Mit O-ring in FKM

Avec joints en FKM

Con junta tórica en FKM

Com O-ring em FKM

- 10 °C

+ 200 °C



Fluidi compatibili

Aria compressa

Fluids

Compressed air

Geeignete Medien

Druckluft

Fluides compatibles

Air comprimé

Fluidos compatibles

Aire comprimido

Fluidos compatíveis

Ar comprimido

Per altri fluidi, consultare l'ufficio tecnico Aignep.

For other fluids, consult the technical department Aignep.

Für andere Flüssigkeiten, kontaktieren Sie uns.

Pour d'autres fluides, veuillez nous consulter.

Para otros fluidos póngase en contacto con el departamento técnico Aignep.

Para outros fluidos consulte o departamento técnico da Aignep.



Portata

NI/min

Flow Rate

Durchflusswerte

Débit

Caudal de Flujo

Vazão

| 6 bar Δ 1 | 6 bar Δ 0.5 | 6 bar * |
|--------------|----------------|------------|
| 1160 | 900 | 1550 |

* Scarico libero - Exhaust Free - Kostenlose Auspuff - Échappement libre - Escape Libre - Descarga livre.



Filettatura

IT

Gas cilindrica conforme ISO 228 Classe A.

Threads

GB

Parallel gas in conformity with ISO 228 Class A.

Gewindearten

DE

Zylindrisches Gewinde nach Norm ISO 228 Classe A.

Filetages

FR

Filetage cylindrique conforme: ISO 228 Classe A.

Roscas

ES

Gas cilindrica conforme ISO 228 Clase A.

Roscas

PT

Gas paralela conforme ISO 228 Classe A.

141

PRESA MASCHIO
MALE SOCKET
VERSCHLUSS-KUPPLUNG MIT AUSSENGEWINDE
COUPLEUR MÂLE
ENCHUFE MACHO
SOQUETE COM ROSCA MACHO

| Code | A | B | C | D | CH | Pack. |
|--------------|-----|----|------|----|----|-------|
| 00141 00 001 | 1/4 | 8 | 51 | 22 | 19 | 10 |
| 00141 00 002 | 3/8 | 9 | 52 | 22 | 19 | 10 |
| 00141 00 003 | 1/2 | 10 | 52.5 | 22 | 24 | 10 |

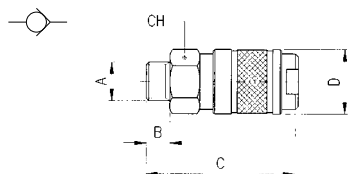

142

PRESA FEMMINA
FEMALE SOCKET
VERSCHLUSS-KUPPLUNG MIT INNENGEWINDE
COUPLEUR FEMELLE
ENCHUFE HEMBRA
SOQUETE COM ROSCA FÊMEA

| Code | A | B | C | D | CH | Pack. |
|--------------|-----|------|------|----|----|-------|
| 00142 00 001 | 1/4 | 11 | 53 | 22 | 19 | 10 |
| 00142 00 002 | 3/8 | 11.5 | 53.5 | 22 | 20 | 10 |
| 00142 00 003 | 1/2 | 14 | 56 | 22 | 24 | 10 |

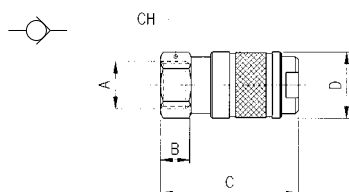

143

PRESA A CALZAMENTO CON MOLLA
COMPRESSION SOCKET WITH SPRING
VERSCHLUSS-KUPPLUNG MIT KNICKSCHUTZFEDER
COUPLEUR AVEC RESSORT DE PROTECTION
ENCHUFE TUBO CON MUELLE
SOQUETE COM CONEXÃO PUSH-ON COM MOLLA

| Code | A | C | D | CH | Pack. |
|--------------|------|-------|----|----|-------|
| 00143 00 001 | 6/4 | 136 | 22 | 19 | 10 |
| 00143 00 002 | 8/6 | 141.5 | 22 | 19 | 10 |
| 00143 00 003 | 10/8 | 148 | 22 | 19 | 10 |

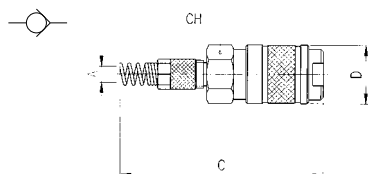

Molla Acciaio Inox AISI 304 - EN 1.4301
 Stainless Steel Spring AISI 304 - EN 1.4301
 Edelstahlfeder AISI 304 - EN 1.4301
 Ressort Acier Inoxydable AISI 304 - EN 1.4301
 Muelle Acero Inoxidable AISI 304 - EN 1.4301
 Mola Aço Inoxidável AISI 304 - EN 1.4301

144

PRESA A CALZAMENTO
COMPRESSION SOCKET
VERSCHLUSS-KUPPLUNG MIT ÜBERWURFVERSCHRAUBUNG
COUPLEUR RACCORD À COIFFE
ENCHUFE TUBO
SOQUETE COM CONEXÃO PUSH-ON

| Code | A | C | D | CH | Pack. |
|--------------|------|----|----|----|-------|
| 00144 00 001 | 6/4 | 54 | 22 | 19 | 10 |
| 00144 00 002 | 8/6 | 54 | 22 | 19 | 10 |
| 00144 00 003 | 10/8 | 54 | 22 | 19 | 10 |

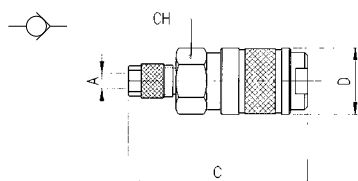

145

PRESA CON PORTAGOMMA A RESCA

SOCKET WITH REST FOR RUBBER HOSE
 VERSCHLUSS-KUPPLUNG MIT SCHLAUCHTÜLLE
 COUPLEUR À DOUILLE ANNELÉE POUR TUBE
 ENCHUFE ESPIGA
 SOQUETE COM ESPIGAO PARA MANGUEIRA DE BORRACHA

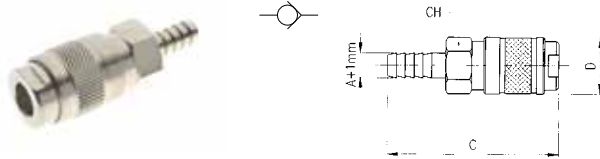

| Code | A | C | D | CH | Pack. |
|--------------|----|------|----|----|-------|
| 00145 00 001 | 6 | 62.5 | 22 | 19 | 10 |
| 00145 00 002 | 8 | 62.5 | 22 | 19 | 10 |
| 00145 00 003 | 10 | 62.5 | 22 | 19 | 10 |
| 00145 00 004 | 12 | 62.5 | 22 | 19 | 10 |

241

INNESTO MASCHIO

MALE PLUG
 STECKER MIT AUSSENGEWINDE
 EMBOUT MÂLE
 ADAPTADOR MACHO
 PLUG COM ROSCA MACHO

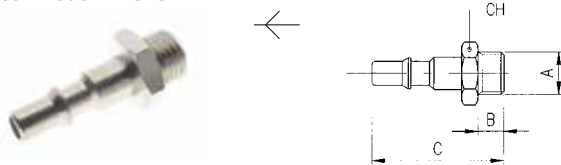

| Code | A | B | C | CH | Pack. |
|-------------------|-----|----|------|----|-------|
| 00241 00 01 03 NB | 1/4 | 8 | 41.5 | 17 | 10 |
| 00241 00 01 04 NB | 3/8 | 9 | 42.5 | 19 | 10 |
| 00241 00 01 05 NB | 1/2 | 10 | 44 | 24 | 10 |

241AC

INNESTO IN ACCIAIO MASCHIO

STEEL MALE PLUG
 STECKER MIT AUSSENGEWINDE AUS STAHL
 EMBOUT MÂLE EN ACIER
 ADAPTADOR EN ACERO MACHO
 PLUG EM AÇO COM ROSCA MACHO

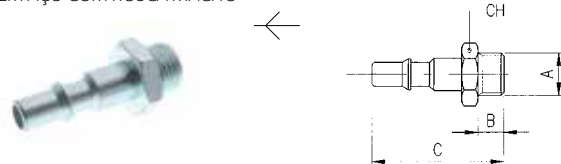

| Code | A | B | C | CH | Pack. |
|-------------------|-----|----|------|----|-------|
| 241AC 00 51 03 ZI | 1/4 | 8 | 41.5 | 17 | 10 |
| 241AC 00 51 04 ZI | 3/8 | 9 | 42.5 | 19 | 10 |
| 241AC 00 51 05 ZI | 1/2 | 10 | 44 | 24 | 10 |

Acciaio Indurito
 Hardened Steel
 Gehärtetem Stahl
 Acier Trempé
 Acero Curtido
 Aço Endurecido

242

INNESTO FEMMINA

FEMALE PLUG
 STECKER MIT INNENGEWINDE
 EMBOUT FEMELLE
 ADAPTADOR HEMBRA
 PLUG COM ROSCA FÊMEA

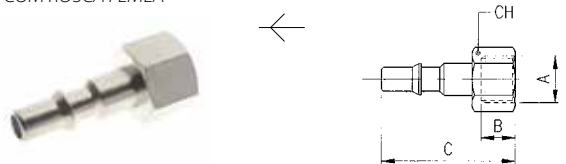

| Code | A | B | C | CH | Pack. |
|-------------------|-----|------|------|----|-------|
| 00242 00 01 03 NB | 1/4 | 11 | 41.5 | 17 | 10 |
| 00242 00 01 04 NB | 3/8 | 11.5 | 42 | 19 | 10 |
| 00242 00 01 05 NB | 1/2 | 14 | 44.5 | 24 | 10 |

242AC

INNESTO IN ACCIAIO FEMMINA

STEEL FEMALE PLUG
 STECKER MIT INNENGEWINDE AUS STAHL
 EMBOUT FEMELLE EN ACIER
 ADAPTADOR EN ACERO HEMBRA
 PLUG EM AÇO COM ROSCA FÊMEA

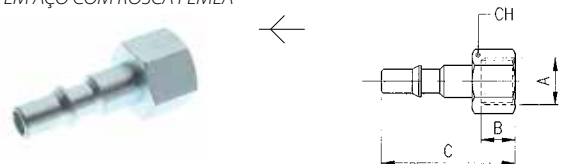

| Code | A | B | C | CH | Pack. |
|-------------------|-----|------|------|----|-------|
| 242AC 00 51 03 ZI | 1/4 | 11 | 41.5 | 17 | 10 |
| 242AC 00 51 04 ZI | 3/8 | 11.5 | 42 | 19 | 10 |
| 242AC 00 51 05 ZI | 1/2 | 14 | 44.5 | 24 | 10 |

Acciaio Indurito
 Hardened Steel
 Gehärtetem Stahl
 Acier Trempé
 Acero Curtido
 Aço Endurecido

243

INNESTO A CALZAMENTO CON MOLLA
 COMPRESSION PLUG WITH SPRING
 STECKER MIT KNICKSCHUTZFEDER
 EMBOUT AVEC RESSORT DE PROTECTION
 ADAPTADOR TUBO CON MUELLE
 PLUG COM CONEXÃO PUSH-ON COM MOLA

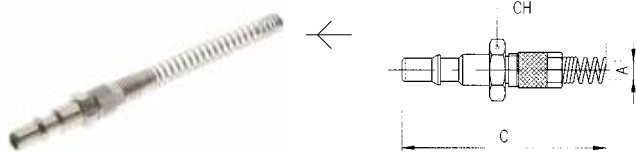

| Code | A | C | CH | Pack. |
|--------------|------|-------|----|-------|
| 00243 00 001 | 6/4 | 128 | 12 | 10 |
| 00243 00 002 | 8/6 | 133.5 | 13 | 10 |
| 00243 00 003 | 10/8 | 140 | 14 | 10 |

Molla Acciaio Inox AISI 304 - EN 1.4301
 Stainless Steel Spring AISI 304 - EN 1.4301
 Edelstahlfeder AISI 304 - EN 1.4301
 Ressort Acier Inoxydable AISI 304 - EN 1.4301
 Muelle Acero Inoxidable AISI 304 - EN 1.4301
 Mola Aço Inoxidável AISI 304 - EN 1.4301

244

INNESTO A CALZAMENTO
 COMPRESSION PLUG
 STECKER MIT ÜBERWURFVERSCHRÄUBUNG
 EMBOUT À RACCORD À COIFFE
 ADAPTADOR TUBO
 PLUG COM CONEXÃO PUSH-ON

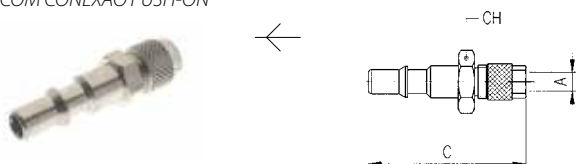

| Code | A | C | CH | Pack. |
|--------------|------|----|----|-------|
| 00244 00 001 | 6/4 | 46 | 12 | 10 |
| 00244 00 002 | 8/6 | 46 | 13 | 10 |
| 00244 00 003 | 10/8 | 48 | 14 | 10 |

245

INNESTO CON PORTAGOMMA A RESCA
 PLUG WITH REST FOR RUBBER HOSE
 STECKER MIT SCHLAUCHTÜLLE
 EMBOUT À DOUILLE ANNELÉE POUR TUBE
 ADAPTADOR ESPIGA
 PLUG COM ESPIGÃO PARA TUBO DE BORRACHA



| Code | A | C | D | Pack. |
|-------------------|----|----|----|-------|
| 00245 00 01 X4 NB | 6 | 48 | 10 | 10 |
| 00245 00 01 X7 NB | 8 | 51 | 12 | 10 |
| 00245 00 01 X9 NB | 10 | 51 | 14 | 10 |
| 00245 00 01 Y1 NB | 12 | 51 | 16 | 10 |

245AC

New

INNESTO IN ACCIAIO CON PORTAGOMMA A RESCA
 STEEL PLUG WITH REST FOR RUBBER HOSE
 STECKER MIT SCHLAUCHTÜLLE AUS STAHL
 EMBOUT À DOUILLE ANNELÉE POUR TUBE EN ACIER
 ADAPTADOR EN ACERO ESPIGA
 PLUG EM AÇO COM ESPIGÃO PARA TUBO DE BORRACHA

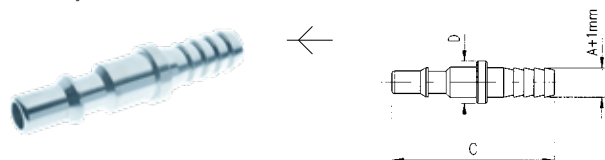

Acciaio Indurito
 Hardened Steel
 Gehärtetem Stahl
 Acier Trempé
 Acero Curtido
 Aço Endurecido

| Code | A | C | D | Pack. |
|-------------------|----|----|----|-------|
| 245AC 00 51 X4 ZI | 6 | 48 | 10 | 10 |
| 245AC 00 51 X7 ZI | 8 | 51 | 12 | 10 |
| 245AC 00 51 X9 ZI | 10 | 51 | 14 | 10 |
| 245AC 00 51 Y1 ZI | 12 | 51 | 16 | 10 |

247

INNESTO A BAIONETTA
 BAYONET PLUG
 STECKER MIT BAJONETT-VERSCHLUSS
 EMBOUT À BAIONETTE
 ADAPTADOR BAYONETA
 PLUG COM CONEXÃO TIPO BAIONETA

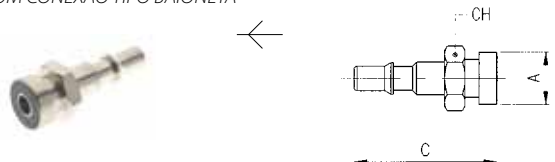

| Code | A | C | CH | Pack. |
|--------------|----|----|----|-------|
| 00247 00 001 | 15 | 42 | 15 | 10 |

248

INNESTO A SCARICO PROGRESSIVO

PLUG WITH GRADUAL EXHAUST
 STECKER MIT PROGRESSIVER ENTLASTUNG
 EMBOUT À PASSAGE PROGRESSIF
 ADAPTADOR DE DESCARGA PROGRESIVA
 PLUG COM ESCAPE PROGRESSIVO

| Code | A | B | C | CH | Pack. |
|---------------------|------------|----|----|----|-------|
| 00248 00 001 | 1/4 | 11 | 50 | 17 | 10 |

